

Key parameter	Value	Unit
$V_{(BR)DSS}$ min.	100	V
$R_{DS(ON)}$ max. $V_{GS}=10V$	6.7	mΩ
$R_{DS(ON)}$ max. $V_{GS}=4.5V$	8.8	mΩ
$I_D$	60.6	A
$V_{GS(TH)}$ Typ.	1.8	V
$C_{iss}$ Typ.	2878	pF
$Q_g$ 10V Typ.	60.5	nC
$E_{AS}$	22.0	mJ

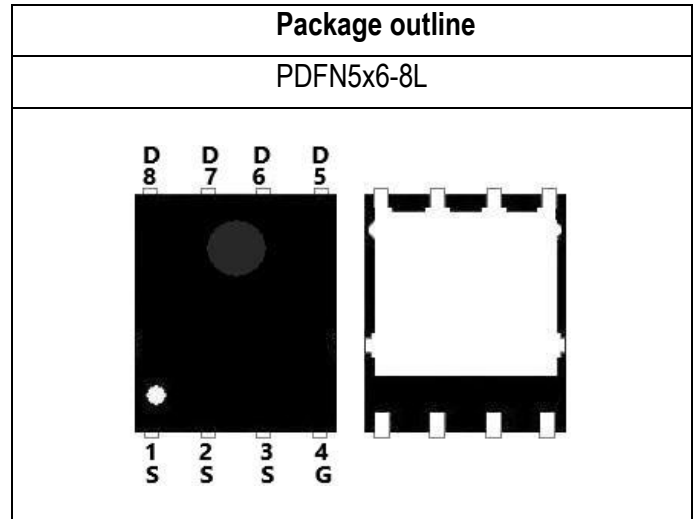

### Description

These devices used double-gate structure of MOSFET to provide excellent electrical parameter. There is high speed switching capacity, low  $R_{DS(ON)}$  resistance, low gate charge and stable characteristics for these devices. Moreover, it is a helpful choose for raise efficiency or reduce consumption in circuit. These features combine to be an advantage design for use in wide variety of application including converter and inverter design.

### Features

- ◇ Fast switch capacity
- ◇ Low  $R_{DS(ON)}$  resistance
- ◇ Low input capacitance
- ◇ With voltage logic level driving characteristics
- ◇ Pb-free lead plating; RoHS compliant

### Potential application

- AC to DC adaptor
- DC to DC Converter
- Power Switch Mode Supply
- Synchronous Rectifier for Power Delivery
- Network equipment and display power supply unit

### Symbol and Pin assignment

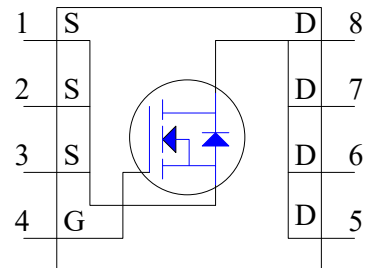

### Order Information

Item	Description
1. Order Code	DG100N19Q
2. Part Number	DG100N19Q
3. Package Type	PDFN5x6-8L
4. Package Code	Q
5. Packing Type	Tape & Reel
6. Quantity in Pack	2,500
7. RoHS Status	Halogen-Free

## Content

Section	Subject	Page
1.	Absolute Maximum Ratings -----	3
2.	Thermal Resistance Ratings -----	3
3.	Electrical Characteristics -----	4
4.	Typical Operating Characteristics Diagram -----	5-7
5.	Marking Information -----	8
6.	Package of Dimension -----	9
7.	Land pattern (Footprint) -----	9
8.	Appendix -----	10-11

## 1. Absolute Maximum Ratings ( $T_J=25^\circ\text{C}$ unless otherwise noted)

Parameter		Symbol	Value	Unit
Drain-Source Voltage		$V_{DS}$	100	V
Gate-Source Voltage		$V_{GS}$	$\pm 20$	V
Drain Current-Continuous <sup>Note 1</sup>	$T_C=25^\circ\text{C}$	$I_D$	60.6	A
	$T_C=100^\circ\text{C}$		38.3	A
Drain Current-Continuous <sup>Note 2</sup>	$T_A=25^\circ\text{C}$	$I_D$	13.5	A
	$T_A=70^\circ\text{C}$		10.8	A
Drain Current-Pulsed <sup>Note 3</sup>	$T_A=25^\circ\text{C}$	$I_{DM}$	200	A
Avalanche Current		$I_{AR}$	21.0	A
Single Pulse Avalanche Energy <sup>Note 4</sup>		$E_{AS}$	22.0	mJ
Maximum Power Dissipation	$T_C=25^\circ\text{C}$	$P_D$	45.6	W
	$T_C=100^\circ\text{C}$		18.2	W
	$T_A=25^\circ\text{C}$		2.28	W
	$T_A=70^\circ\text{C}$		1.46	W
	Derate Factor Above $T_C=25^\circ\text{C}$		0.36	W/ $^\circ\text{C}$
Max. Operating Junction Temperature		$T_J$	150	$^\circ\text{C}$
Operating and Storage Temperature Range		$T_J, T_{STG}$	-55 to 150	$^\circ\text{C}$

## 2. Thermal Resistance Ratings

Parameter	Symbol	Conditions	Min.	Typ.	Max.	Unit
Thermal resistance, Junction-Case	$R_{\theta JC-N}$	Please refer to Note 5	-	-	2.74	$^\circ\text{C}/\text{W}$
Thermal resistance, Junction-Ambient	$R_{\theta JA-N}$	Please refer to Note 5	-	-	54.72	$^\circ\text{C}/\text{W}$

### Notes:

- Limited by silicon chip capability and  $R_{\theta JC-N}$  junction-to-case thermal resistance.
- The maximum current rating is limited by package and  $R_{\theta JA-N}$  junction-to-ambient thermal resistance.
- Must be ensure junction temperature does not exceed 150-degree C. (Pulse Width  $\leq 380\mu\text{s}$ , Duty  $\leq 2\%$ )
- Limited by  $T_{Jmax}$ , starting  $T_J=25^\circ\text{C}$ ,  $L=0.1\text{mH}$ ,  $R_g=25\Omega$ ,  $I_D=21.0\text{A}$ ,  $V_{GS}=10\text{V}$ .
- The value of thermal resistance is measured with the single device mounted on 1 inch<sup>2</sup> FR-4 PCB with 2 oz. copper under a still air environment temperature is  $25^\circ\text{C}$  based on JEDEC standard JESD51-14 and JESD51-2a. Thermal resistance obtained depends on the user's specific board design and given application.

### 3. Electrical Characteristics (T<sub>J</sub>=25°C unless otherwise noted)

STATIC CHARACTERISTICS						
Parameter	Symbol	Conditions	Min.	Typ.	Max.	Unit
Drain-Source Breakdown Voltage	V <sub>(BR)DSS</sub>	V <sub>GS</sub> =0V, I <sub>DS</sub> =250μA	100	-	-	V
Zero Gate Voltage Drain Current	I <sub>DSS</sub>	V <sub>DS</sub> =100V, V <sub>GS</sub> =0V	-	-	1	μA
		V <sub>DS</sub> =100V, V <sub>GS</sub> =0V, T <sub>J</sub> =125°C	-	-	100	μA
Gate-Body Leakage	I <sub>GSS</sub>	V <sub>GS</sub> =±20V, V <sub>DS</sub> =0V	-	-	±100	nA

STATIC CHARACTERISTICS						
Parameter	Symbol	Conditions	Min.	Typ.	Max.	Unit
Gate Threshold Voltage	V <sub>GS(TH)</sub>	V <sub>DS</sub> =V <sub>GS</sub> , I <sub>DS</sub> =250μA	1.5	1.8	2.1	V
Drain-Source On-State Resistance	R <sub>DS(ON)</sub>	V <sub>GS</sub> =10V, I <sub>DS</sub> =50A	-	5.9	6.7	mΩ
Drain-Source On-State Resistance	R <sub>DS(ON)</sub>	V <sub>GS</sub> =4.5V, I <sub>DS</sub> =30A	-	7.7	8.8	mΩ
Gate Resistance	R <sub>g</sub>	V <sub>GS</sub> =0V, V <sub>DS</sub> =0V, f=1MHz	-	0.8	-	Ω
Forward Transconductance	g <sub>fs</sub>	V <sub>DS</sub> =5V, I <sub>DS</sub> =20A	-	33.1	-	S

DYNAMIC CHARACTERISTICS						
Parameter	Symbol	Conditions	Min.	Typ.	Max.	Unit
Input Capacitance	C <sub>iss</sub>	V <sub>DD</sub> =100V, V <sub>DS</sub> =50V, V <sub>GS</sub> =0V, F=1MHz	-	2878	-	pF
Output Capacitance	C <sub>oss</sub>	V <sub>DD</sub> =100V, V <sub>DS</sub> =50V, V <sub>GS</sub> =0V, F=1MHz	-	442	-	pF
Reverse Transfer Capacitance	C <sub>rss</sub>	V <sub>DD</sub> =100V, V <sub>DS</sub> =50V, V <sub>GS</sub> =0V, F=1MHz	-	10.7	-	pF
Turn-On Delay Time	T <sub>d(on)</sub>	V <sub>DS</sub> =50V, V <sub>GS</sub> =10V, I <sub>DS</sub> =20A, R <sub>GEN</sub> =2.4Ω	-	11.0	-	nS
Rise Time	T <sub>r</sub>	V <sub>DS</sub> =50V, V <sub>GS</sub> =10V, I <sub>DS</sub> =20A, R <sub>GEN</sub> =2.4Ω	-	26.6	-	nS
Turn-Off Delay Time	T <sub>d(off)</sub>	V <sub>DS</sub> =50V, V <sub>GS</sub> =10V, I <sub>DS</sub> =20A, R <sub>GEN</sub> =2.4Ω	-	43.3	-	nS
Fall Time	T <sub>f</sub>	V <sub>DS</sub> =50V, V <sub>GS</sub> =10V, I <sub>DS</sub> =20A, R <sub>GEN</sub> =2.4Ω	-	26.7	-	nS

GATE CHARGE CHARACTERISTICS						
Parameter	Symbol	Conditions	Min.	Typ.	Max.	Unit
Gate to Source Gate Charge	Q <sub>gs</sub>	V <sub>DD</sub> =50V, I <sub>b</sub> =20A, V <sub>GS</sub> =0 to 10V	-	10.6	-	nC
Gate charge at threshold	Q <sub>g(th)</sub>	V <sub>DD</sub> =50V, I <sub>b</sub> =20A, V <sub>GS</sub> =0 to 10V	-	5.5	-	nC
Gate to Drain Charge	Q <sub>gd</sub>	V <sub>DD</sub> =50V, I <sub>b</sub> =20A, V <sub>GS</sub> =0 to 10V	-	16.2	-	nC
Switching charge	Q <sub>sw</sub>	V <sub>DD</sub> =50V, I <sub>b</sub> =20A, V <sub>GS</sub> =0 to 10V	-	21.3	-	nC
Gate charge total	Q <sub>g 10V</sub>	V <sub>DD</sub> =50V, I <sub>b</sub> =20A, V <sub>GS</sub> =0 to 10V	-	60.5	-	nC
Gate charge total	Q <sub>g 4.5V</sub>	V <sub>DD</sub> =50V, I <sub>b</sub> =20A, V <sub>GS</sub> =0 to 10V	-	31.6	-	nC
Gate plateau voltage	V <sub>plateau</sub>	V <sub>DD</sub> =50V, I <sub>b</sub> =20A, V <sub>GS</sub> =0 to 10V	-	3.4	-	V
Gate charge total, sync. FET (Q <sub>g</sub> - Q <sub>gd</sub> )	Q <sub>g(sync)</sub>	V <sub>DS</sub> =0.1V, V <sub>GS</sub> =0 to 10V	-	44.3	-	nC

DRAIN-SOURCE DIODE CHARACTERISTICS AND MAXIMUM RATINGS						
Parameter	Symbol	Conditions	Min.	Typ.	Max.	Unit
Body Diode continuous forward current	I <sub>s</sub>	T <sub>C</sub> =25°C	-	-	60.6	A
Body Diode pulse current	I <sub>SM</sub>	T <sub>C</sub> =25°C	-	-	200	A
Body Diode Forward Voltage	V <sub>SD</sub>	V <sub>GS</sub> =0V, I <sub>s</sub> =50A	-	0.93	1.0	V
Body Diode Reverse Recovery Time	t <sub>rr</sub>	V <sub>DD</sub> =50V, I <sub>F</sub> =20A, di/dt=100A/μs	-	54.4	-	nS
Body Diode Reverse Recovery Charge	Q <sub>rr</sub>	V <sub>DD</sub> =50V, I <sub>F</sub> =20A, di/dt=100A/μs	-	70.9	-	nC
Body Diode Reverse Recovery Current	I <sub>rm</sub>	V <sub>DD</sub> =50V, I <sub>F</sub> =20A, di/dt=100A/μs	-	2.21	-	A

4. Typical Operating Characteristics Diagram

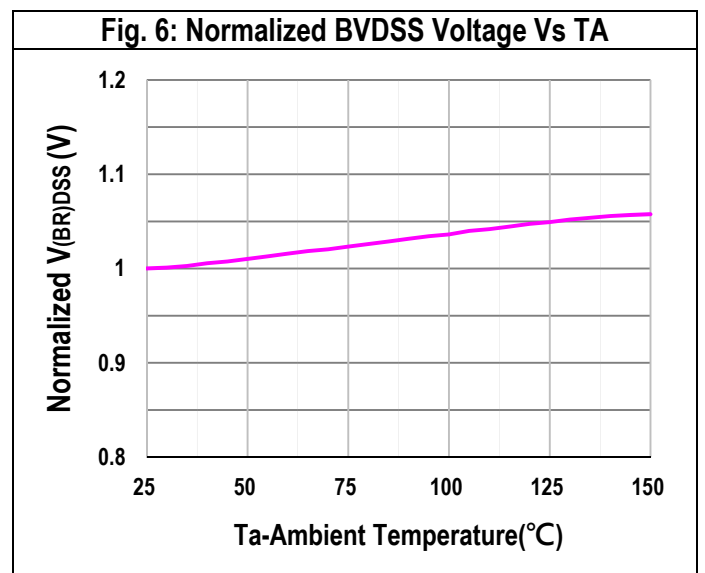
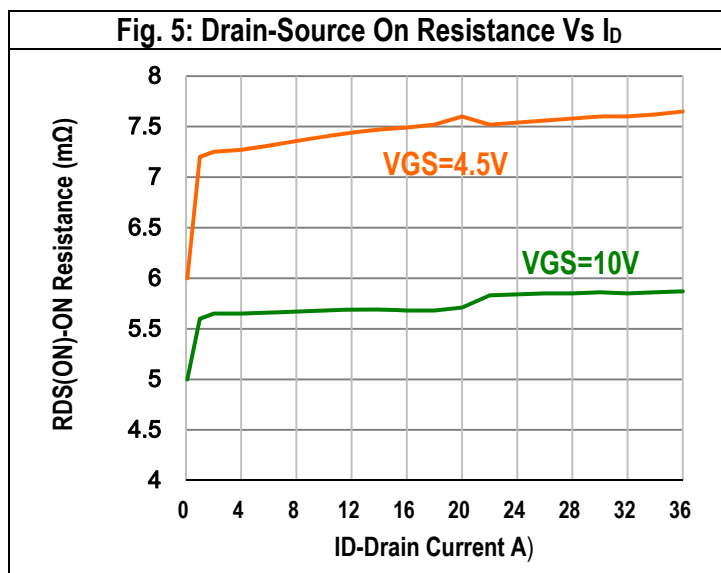
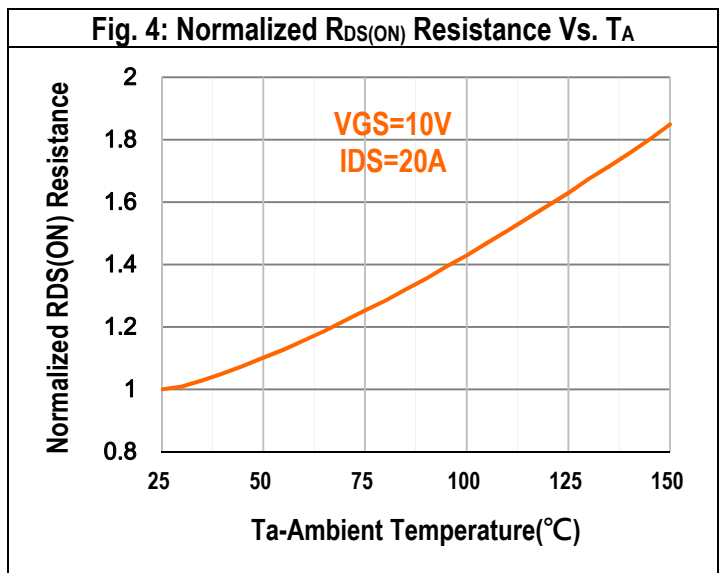
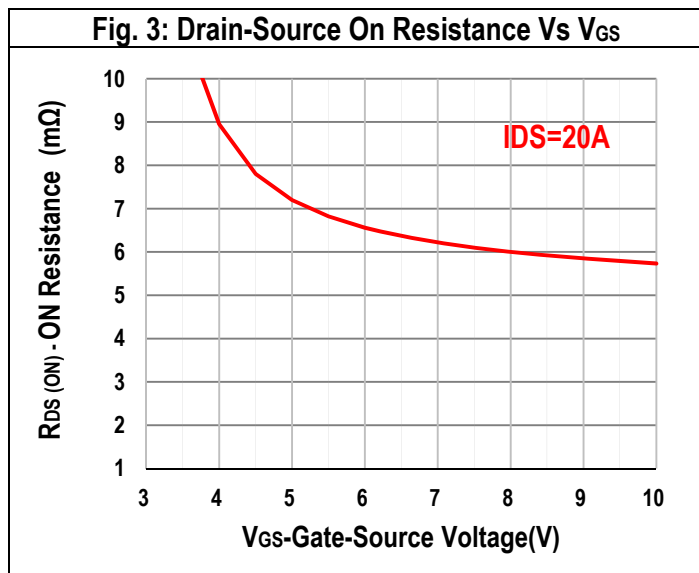
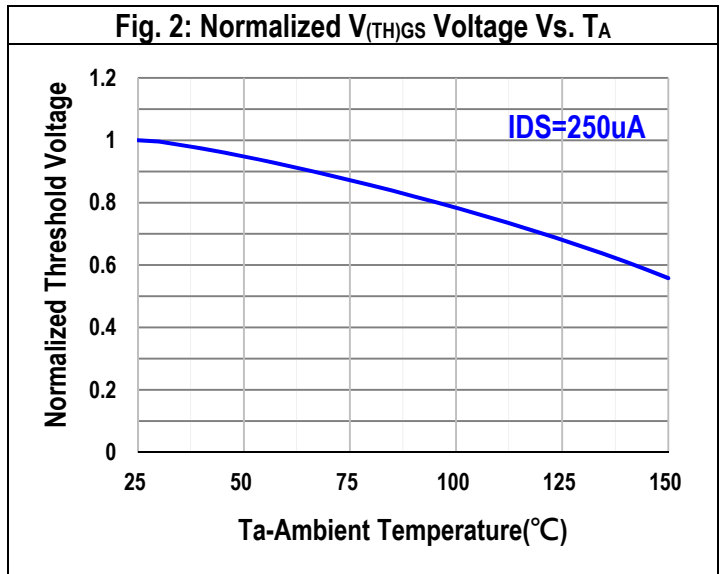
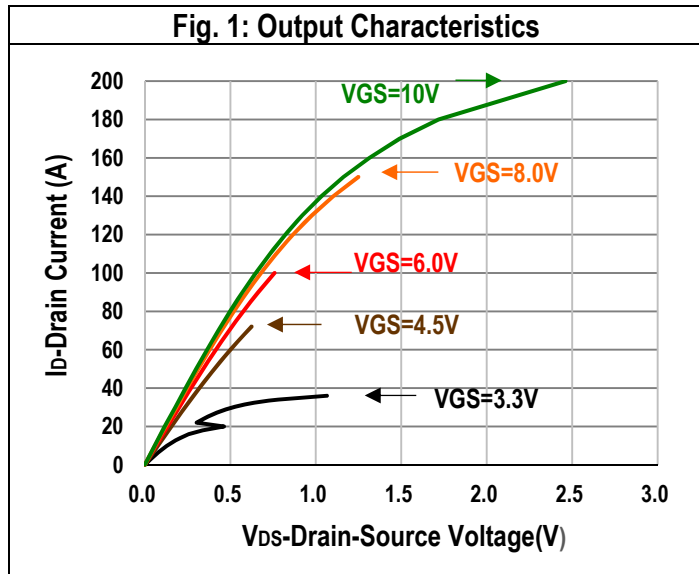

4. Typical Operating Characteristics Diagram

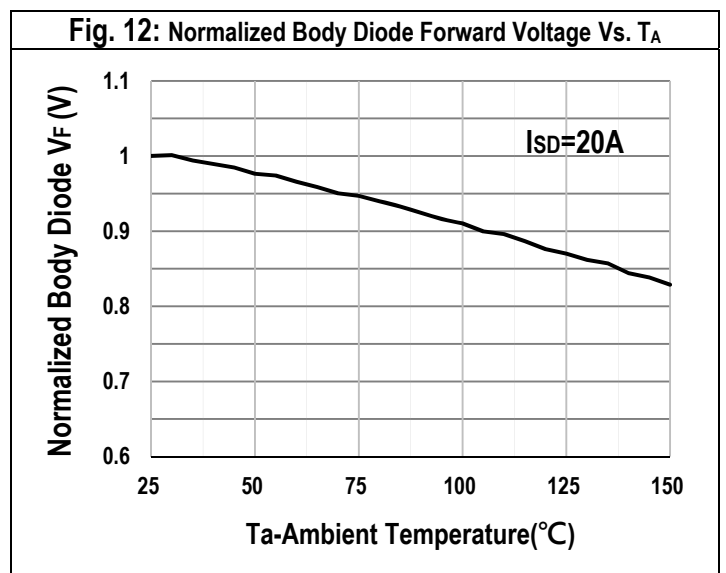
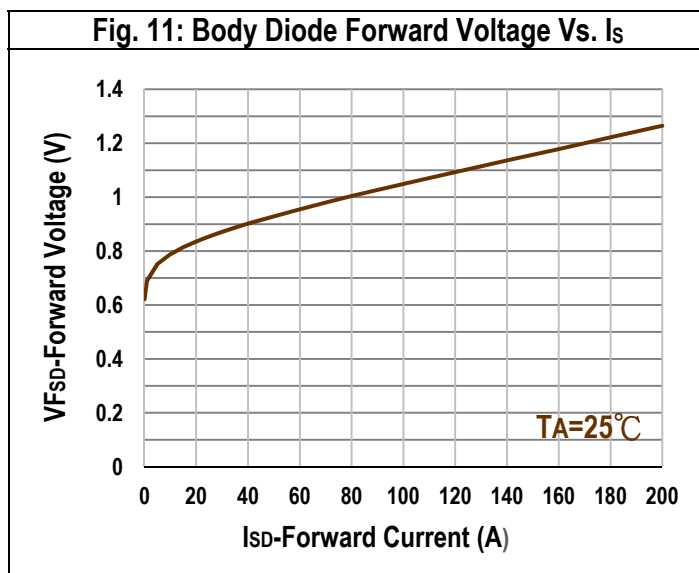
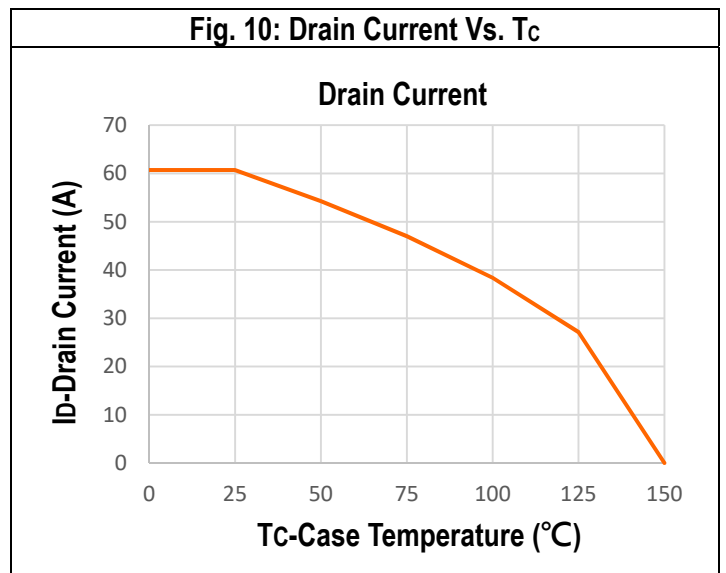
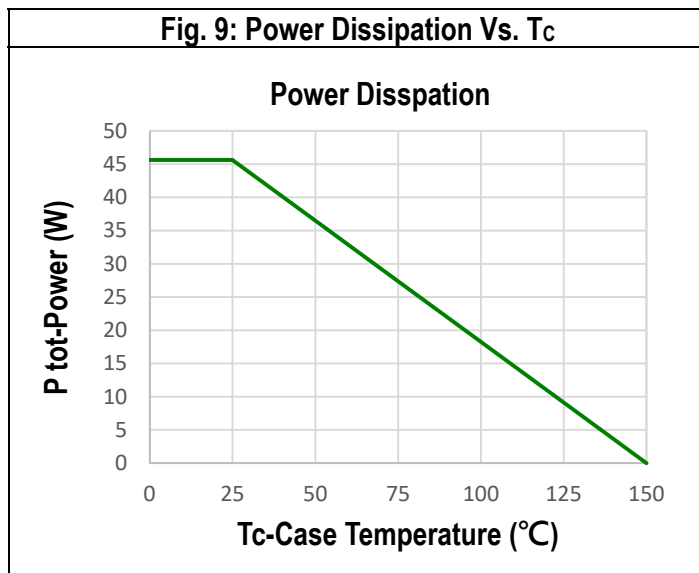
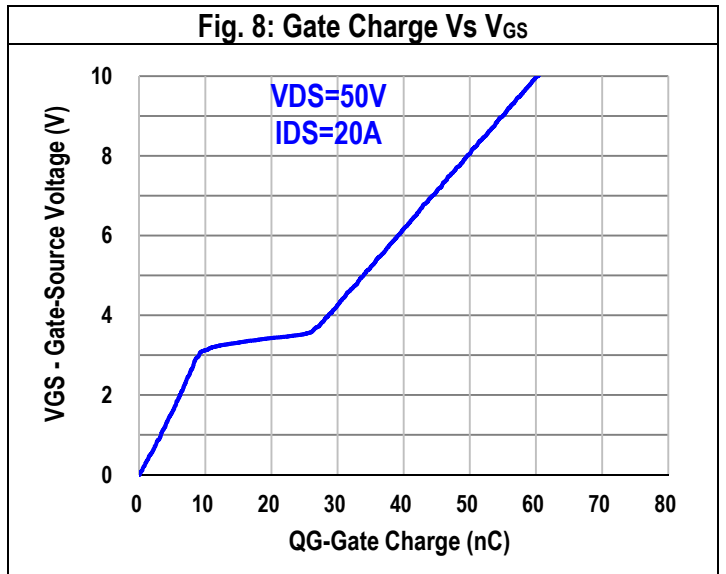
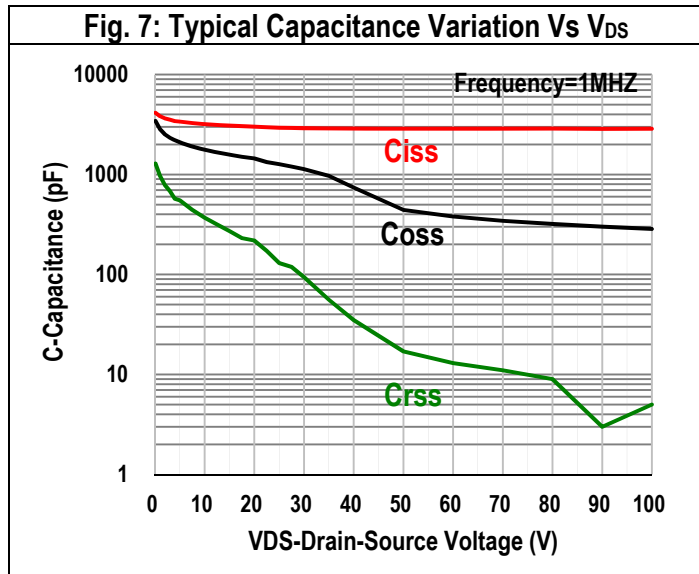

4. Typical Operating Characteristics Diagram

Fig. 13: Safe Operation Area

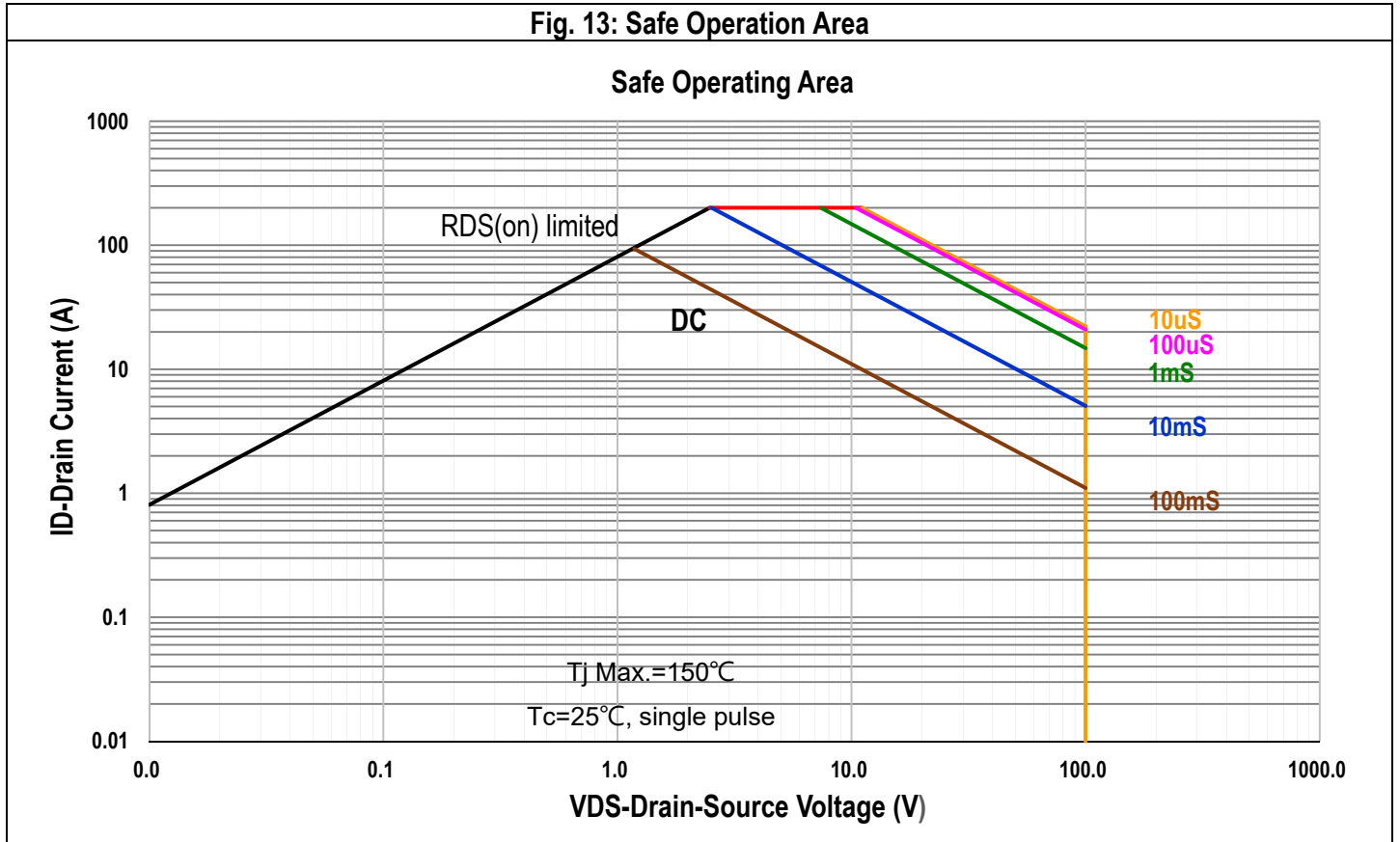
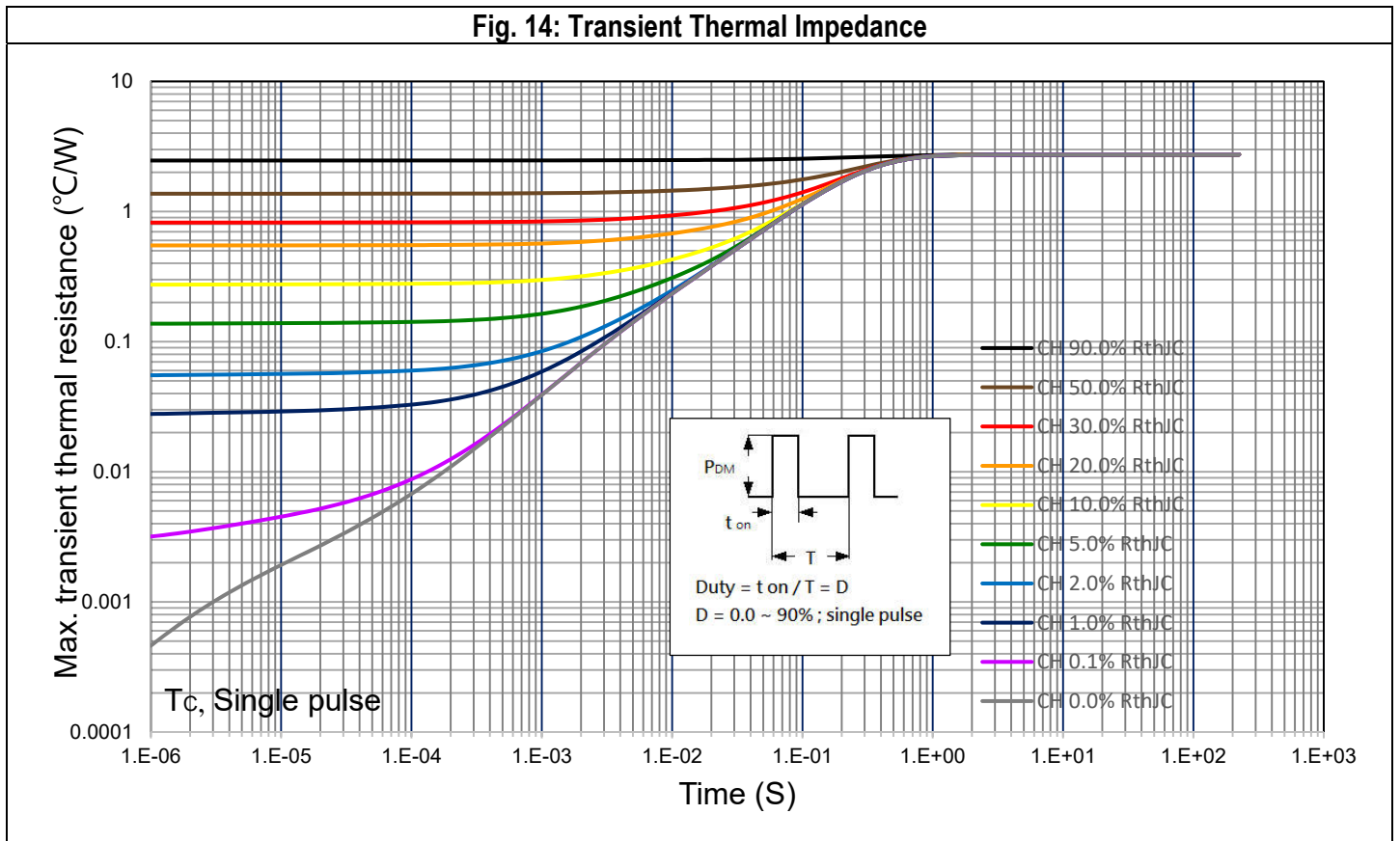
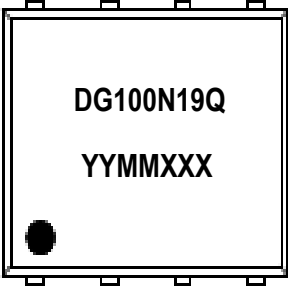

Fig. 14: Transient Thermal Impedance



**5. Marking Information**

PDFN 5x6-8L (Q)	Marking Rule
<p>Laser Marking</p> 	<p><u>Line 1</u> : Device DG100N19Q</p> <p><u>Line 2</u> : Date Code YYMMXXX</p> <p>YY : Year Code MM : Month Code XXX : Serial Number</p>



## 6. Package of Dimension

Package type: PDFN 5x6-8L

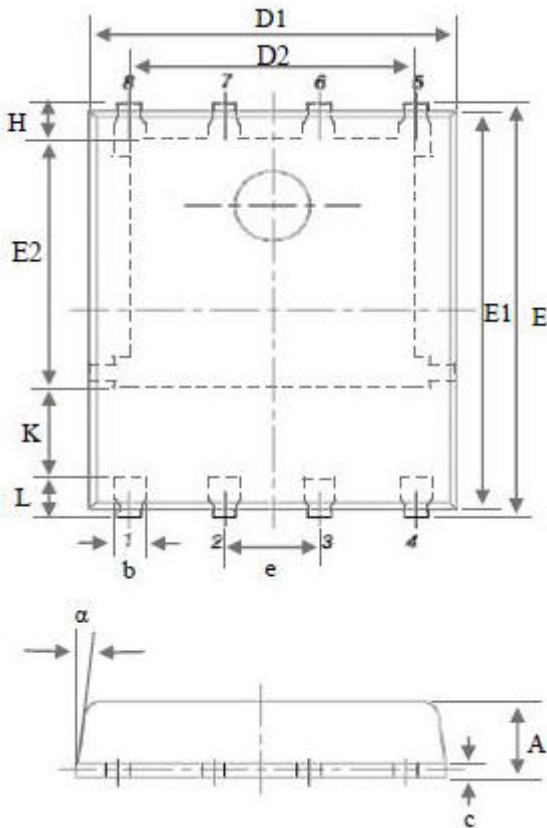

Symbol	Min	Nor	Max
A	0.90	1.04	1.17
b	0.33	0.42	0.51
C	0.06	0.20	0.35
D1	4.80	5.10	5.40
D2	3.61	3.96	4.31
E	5.90	6.03	6.15
E1	5.65	5.75	5.85
E2	3.30	3.54	3.78
e	1.27 BSC		
H	0.38	0.50	0.61
L	0.38	0.55	0.71
L1	0.05	0.15	0.25

## 7. Land pattern (Footprint)

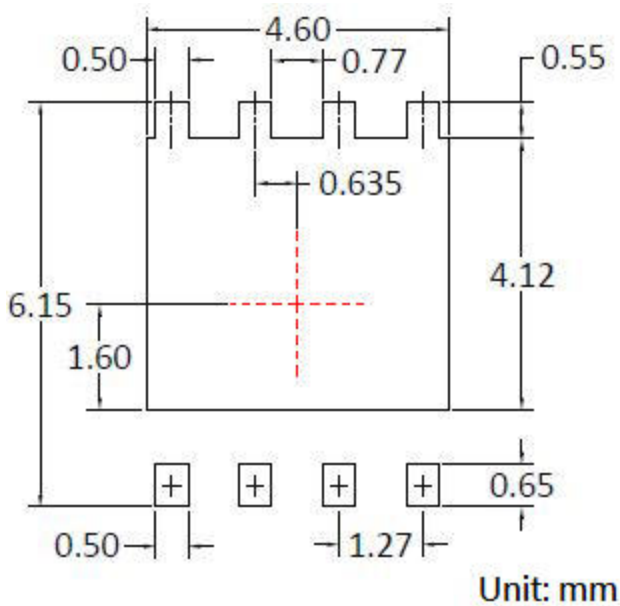

- Note 1: Land pattern (Footprint) design is for reference only.
- Note 2: Package body sizes exclude mold flash and burrs.
- Note 3: Dimension is measured in gauge plane.
- Note 4: Tolerance 0.1mm unless otherwise specified.

## 8. Appendix-A

### Soldering Methods for Silicongear's Products (Just for SMD type of device)

1. Storage environment: Temperature=10°C to 35°C Humidity=65%±15%
2. Reflow soldering of surface-mount devices

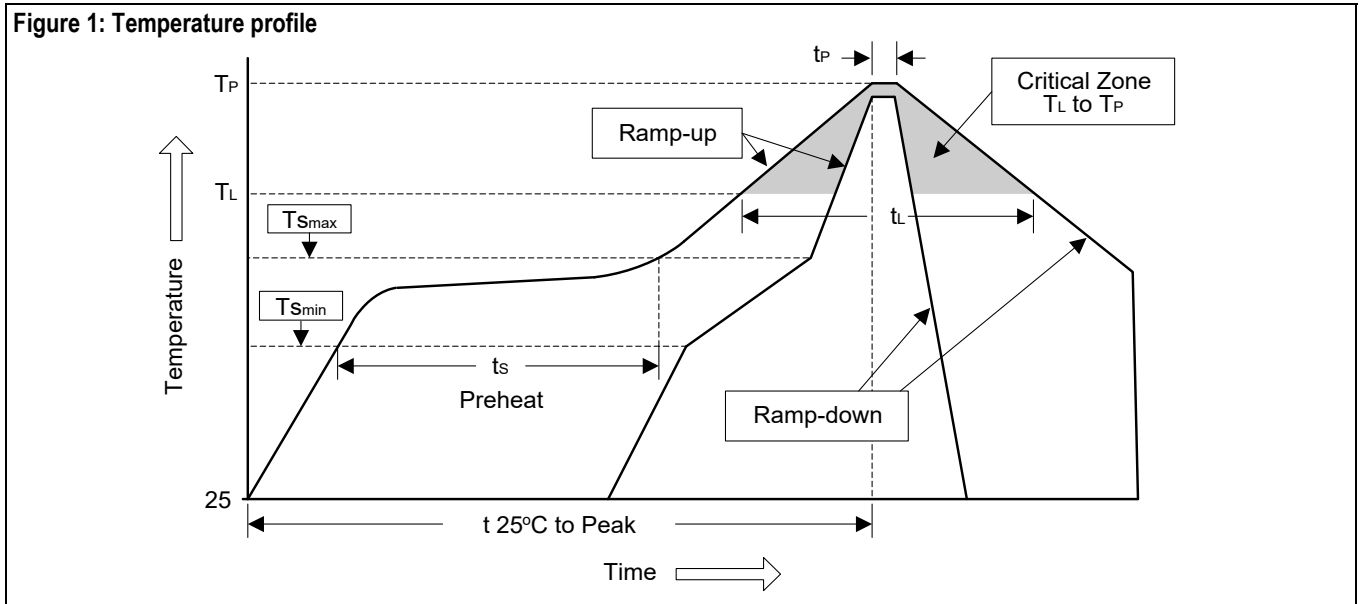

Profile Feature	Sn-Pb Eutectic Assembly	Pb-Free Assembly
Average ramp-up rate ( $T_L$ to $T_P$ )	<3°C/sec	<3°C/sec
Preheat		
- Temperature Min ( $T_{smin}$ )	100°C	150°C
- Temperature Max ( $T_{smax}$ )	150°C	200°C
- Time (min to max) ( $t_s$ )	60 to 120 sec	60 to 180 sec
$T_{smax}$ to $T_L$		
- Ramp-up Rate	<3°C/sec	<3°C/sec
Time maintained above:		
- Temperature ( $T_L$ )	183°C	217°C
- Time ( $t_L$ )	60 to 150 sec	60 to 150 sec
Peak Temperature ( $T_P$ )	240°C +0/-5°C	260°C +0/-5°C
Time within 5°C of actual Peak Temperature ( $t_P$ )	10 to 30 sec	20 to 40 sec
Ramp-down Rate	<6°C/sec	<6°C/sec
Time 25°C to Peak Temperature	<6 minutes	<8 minutes

### 3. Flow (wave) soldering (solder dipping)

Products	Peak Temperature	Dipping Time
Pb devices.	245°C ±5°C	5sec ±1sec
Pb-Free devices.	260°C +0/-5°C	5sec ±1sec

**8. Appendix-B****Important Notice****© Silicongear Corporation**

ALL PRODUCT, PRODUCT SPECIFICATIONS AND DATA ARE SUBJECT TO CHANGE WITHOUT NOTICE TO IMPROVE RELIABILITY, FUNCTION OR DESIGN OR OTHERWISE.

Silicongear cannot assume responsibility for use of any circuitry other than circuitry entirely embodied in an Silicongear product. No circuit patent licenses, copyrights, mask work rights, or other intellectual property rights are implied.

Silicongear Corporation, its affiliates, agents, and employees, and all persons acting on its or their behalf (collectively, "Silicongear"), disclaim any and all liability for any errors, inaccuracies or incompleteness contained in any datasheet or in any other disclosure relating to any product.

Silicongear makes no warranty, representation or guarantee regarding the suitability of the products for any particular purpose or the continuing production of any product. To the maximum extent permitted by applicable law, Silicongear disclaims (i) any and all liability arising out of the application or use of any product, (ii) any and all liability, including without limitation special, consequential or incidental damages, and (iii) any and all implied warranties, including warranties of fitness for particular purpose, non-infringement and merchantability.

Statements regarding the suitability of products for certain types of applications are based on Silicongear's knowledge of typical requirements that are often placed on Silicongear products in generic applications. Such statements are not binding statements about the suitability of products for a particular application. It is the customer's responsibility to validate that a particular product with the properties described in the product specification is suitable for use in a particular application. Parameters provided in datasheets and/or specifications may vary in different applications and performance may vary over time. All operating parameters, including typical parameters, must be validated for each customer application by the customer's technical experts. Product specifications do not expand or otherwise modify Silicongear's terms and conditions of purchase, including but not limited to the warranty expressed therein.

Except as expressly indicated in writing, Silicongear products are not designed for use in medical, life-saving, or life-sustaining applications or for any other application in which the failure of the Silicongear product could result in personal injury or death. Customers using or selling Silicongear products not expressly indicated for use in such applications do so at their own risk and agree to fully indemnify and hold Silicongear and its distributors harmless from and against any and all claims, liabilities, expenses and damages arising or resulting in connection with such use or sale, including attorneys fees, even if such claim alleges that Silicongear or its distributor was negligent regarding the design or manufacture of the part. Please contact authorized Silicongear personnel to obtain written terms and conditions regarding products designed for such applications.

No license, express or implied, by estoppel or otherwise, to any intellectual property rights is granted by this document or by any conduct of Silicongear. Product names and markings noted herein may be trademarks of their respective owners.

Silicongear and the Silicongear logo are trademarks of Silicongear Corporation. All other brand and product names appearing in this document are registered trademarks or trademarks of their respective holders.